

PRODOTTI / RICAMBI
PRODUCTS / SPARE PARTS
PRODUITS / PIÈCES DÉTACHÉES
PRODUKTE / ERSATZTEILE
PRODUCTOS / REPUESTOS

TALENTO

Esplosi
Versioni Special / Plus

20/12/2016

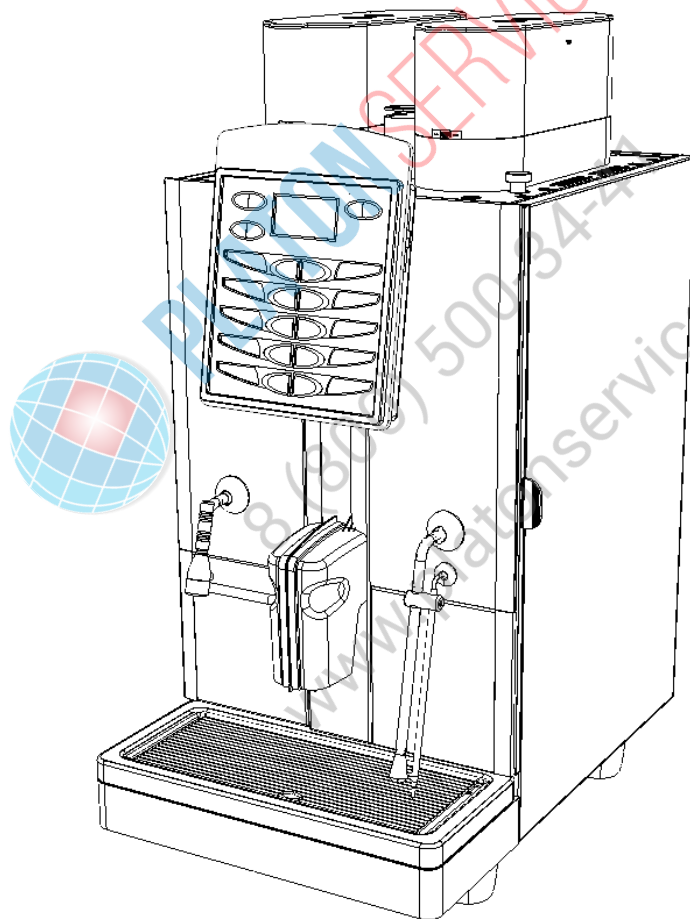

 nuova
SIMONELLI®

I N D I C E

- » TAV 01 - COMPONENTI GRUPPO CARENA
- » TAV 02 - COMPONENTI PORTA SERVIZI FRONTALE
- » TAV 03 - COMPONENTI GRUPPO TELAIO
- » TAV 03 MK - COMPONENTI LATTE
- » TAV 04 - COMPONENTI GRUPPO POMPA
- » TAV 05 - COMPONENTI IDRAULICI STANDARD
- » TAV 06 - COMPONENTI IDRAULICI KIT ECONOMIZZATORE
- » TAV 07 - COMPONENTI GRUPPO EROGAZIONE
- » TAV 08 - COMPONENTI GRUPPO CALDAIE
- » TAV 09 - COMPONENTI ELETTRICI ED ELETTRONICI

» LEGENDA :

I CODICI SCRITTI IN GRASSETTO SI RIFERISCONO AI COMPONENTI IMPIEGATI ATTUALMENTE.

I CODICI IMPIEGATI PRIMA SONO SCRITTI IN CORSIVO CON INDICATA A FIANCO LA DATA DI FINE VALIDITA'.

ESEMPIO:

03001531 - 01/09/2007

03001531

COMPONENTI GRUPPO CARENA

BODYWORK COMPONENTS

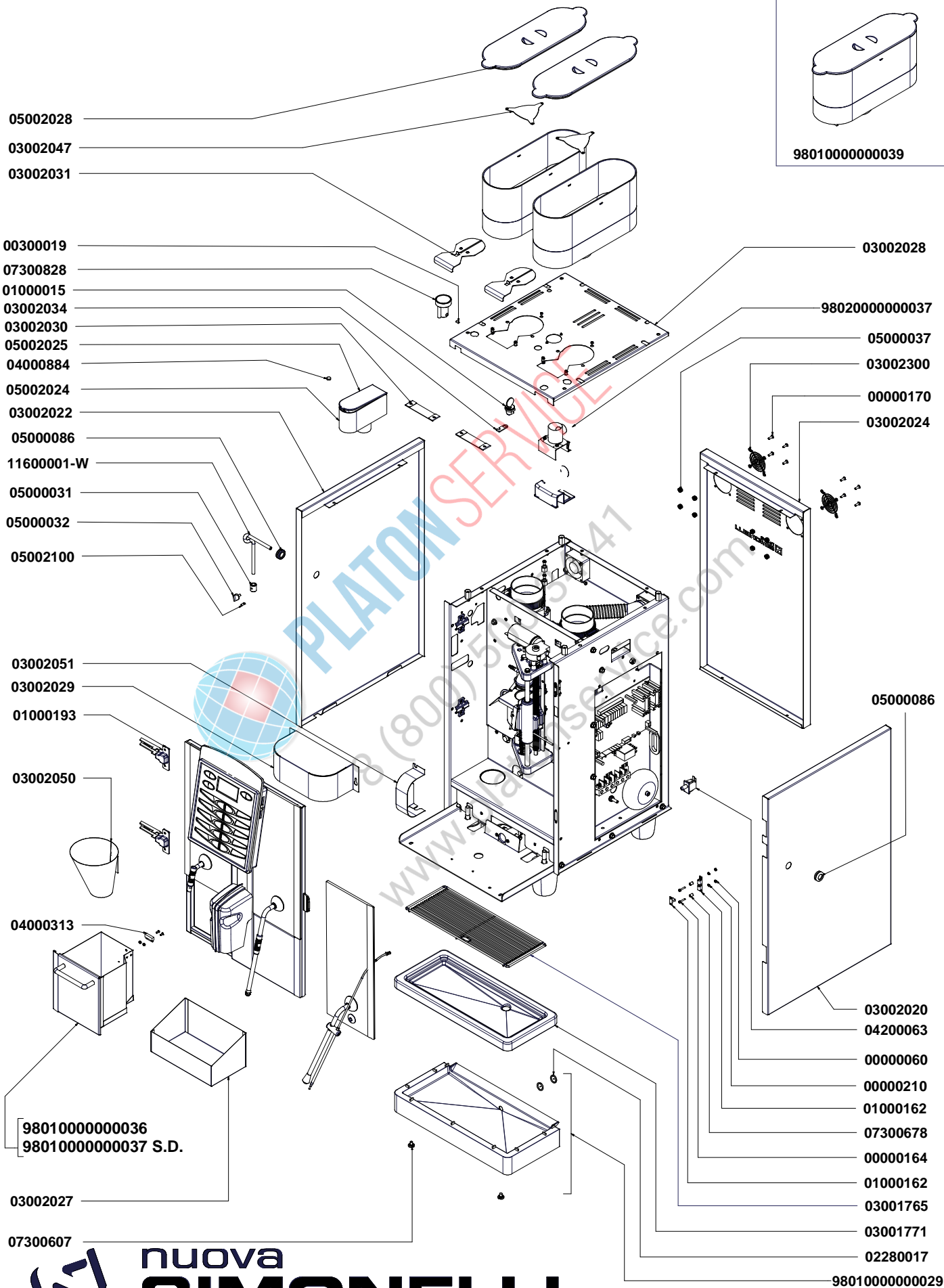

nuova
SIMONELLI

PORTA SERVIZI FRONTALE SERVICES DOOR PANEL

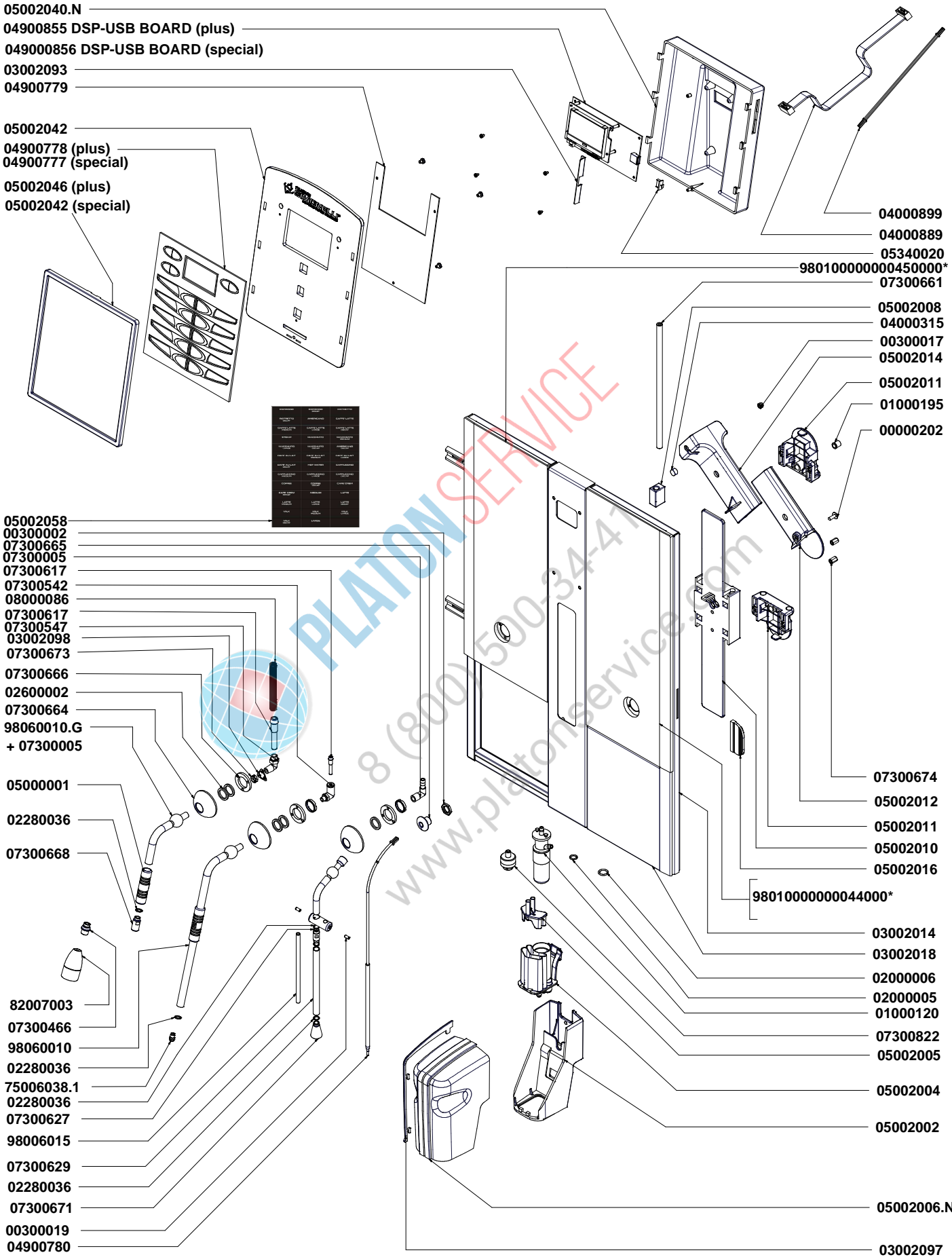

nuova simonelli

* SPECIFICARE VERSIONE E COLORE
* SPECIFY VERSION AND COLOUR

COMPONENTI GRUPPO TELAIO

FRAME COMPONENTS

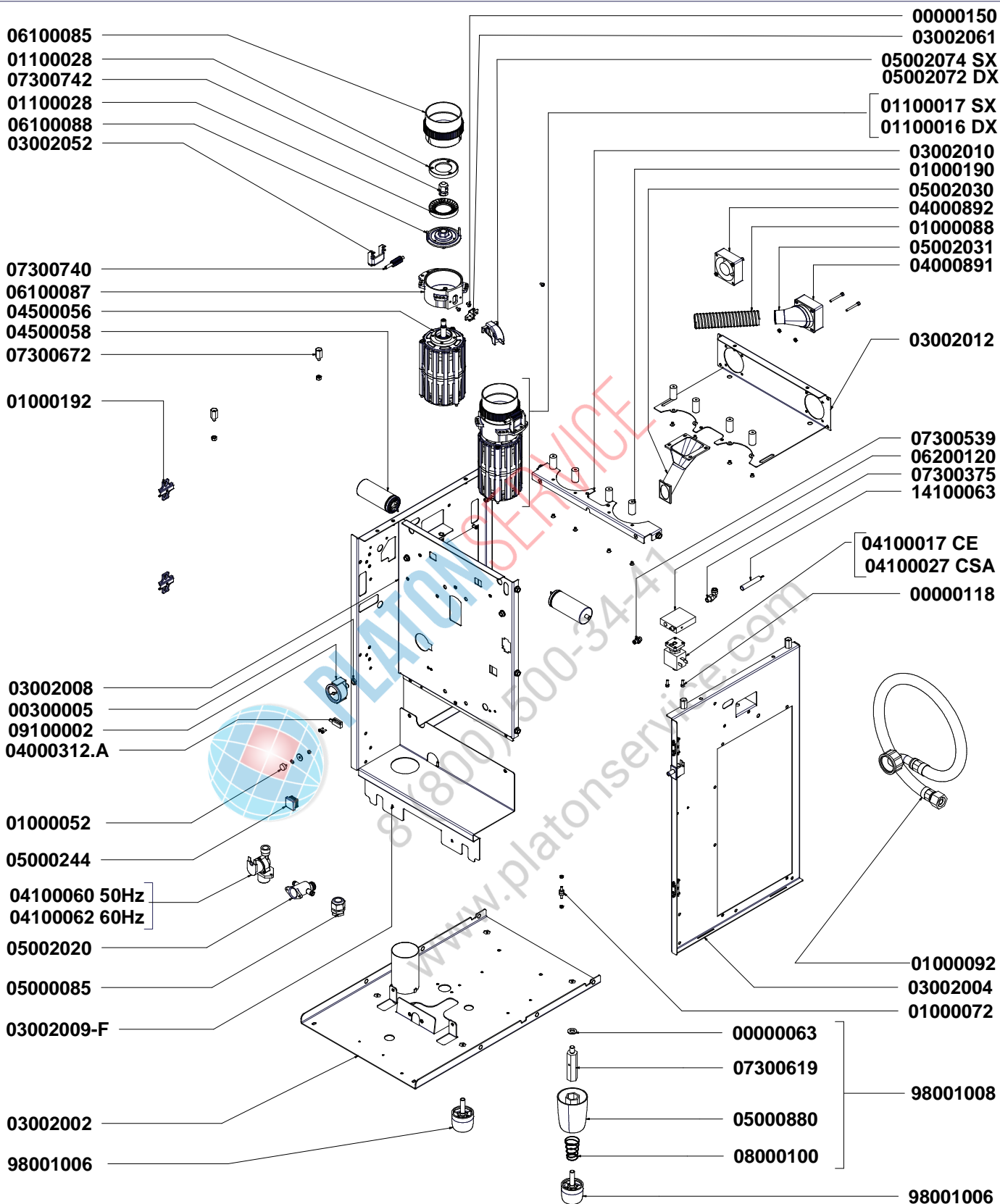

CODICE/CODE	DESCRIZIONE	DESCRIPTION
00000070	Fascetta per tubo scarico diretto fondi	Sgt clip 50/70 9 W2
00000133	Fascetta per tubo scarico diretto acqua	Stainless steel girdle WD12 16-25 C7 W2
01000080	Tubo D=60 per scarico fondi	Spiral pipe for dregs drain D=60
01000087	Tubo scarico acqua 18x24.4	Drain pipe 18x24.4

COMPONENTI LATTE MILK COMPONENTS

SPECIAL

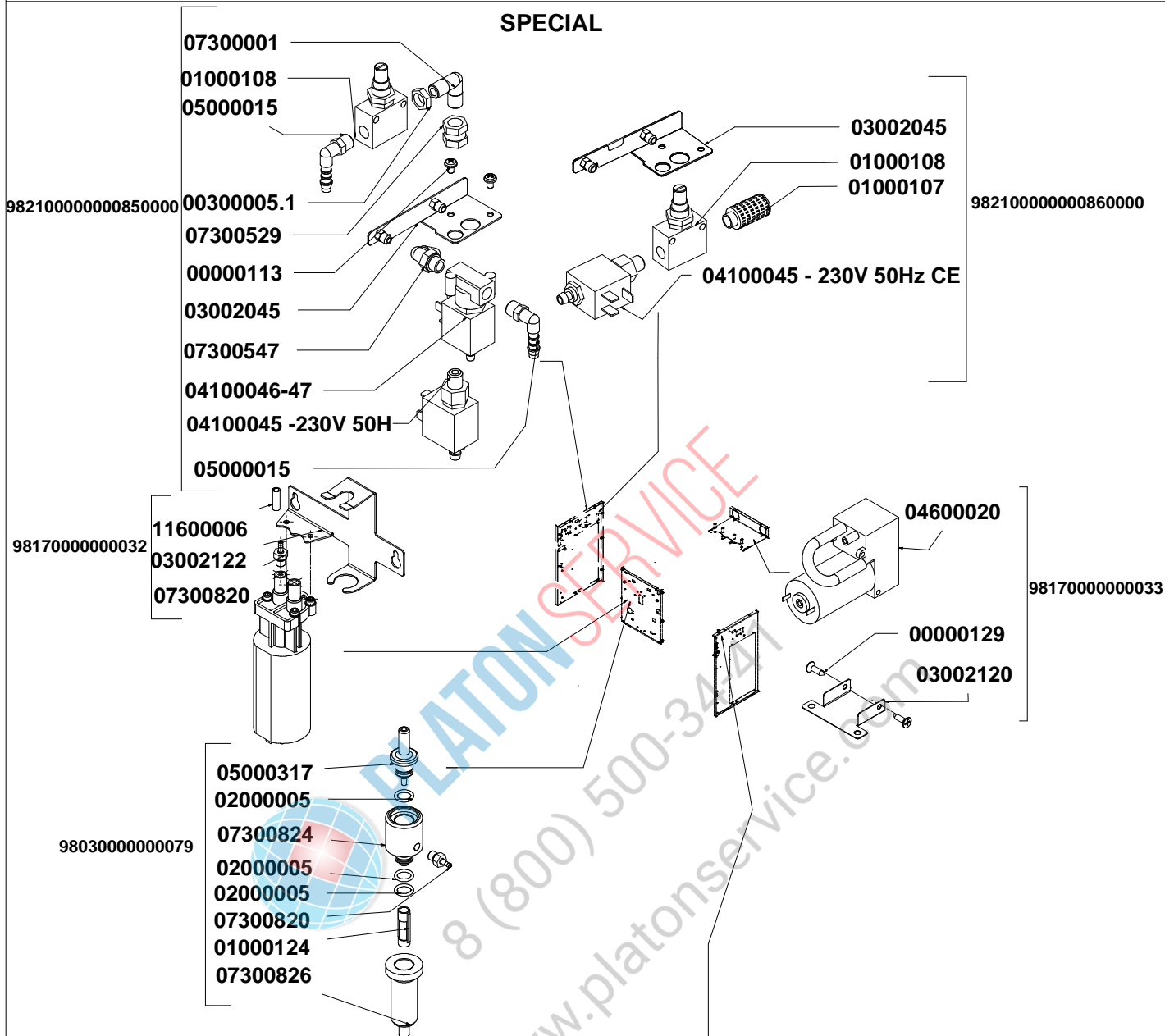

EASY CREAM

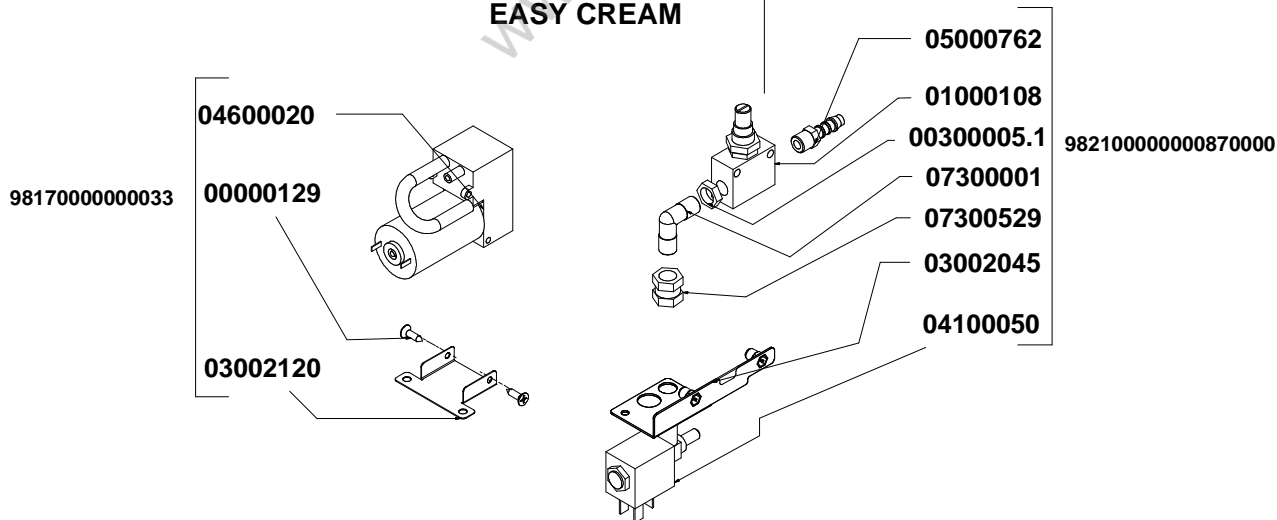

COMPONENTI GRUPPO POMPA PUMP GROUP COMPONENTS

VERSIONE STANDARD STANDARD VERSION

VERSIONE CON MISCELATORE ECONOMIZER VERSION

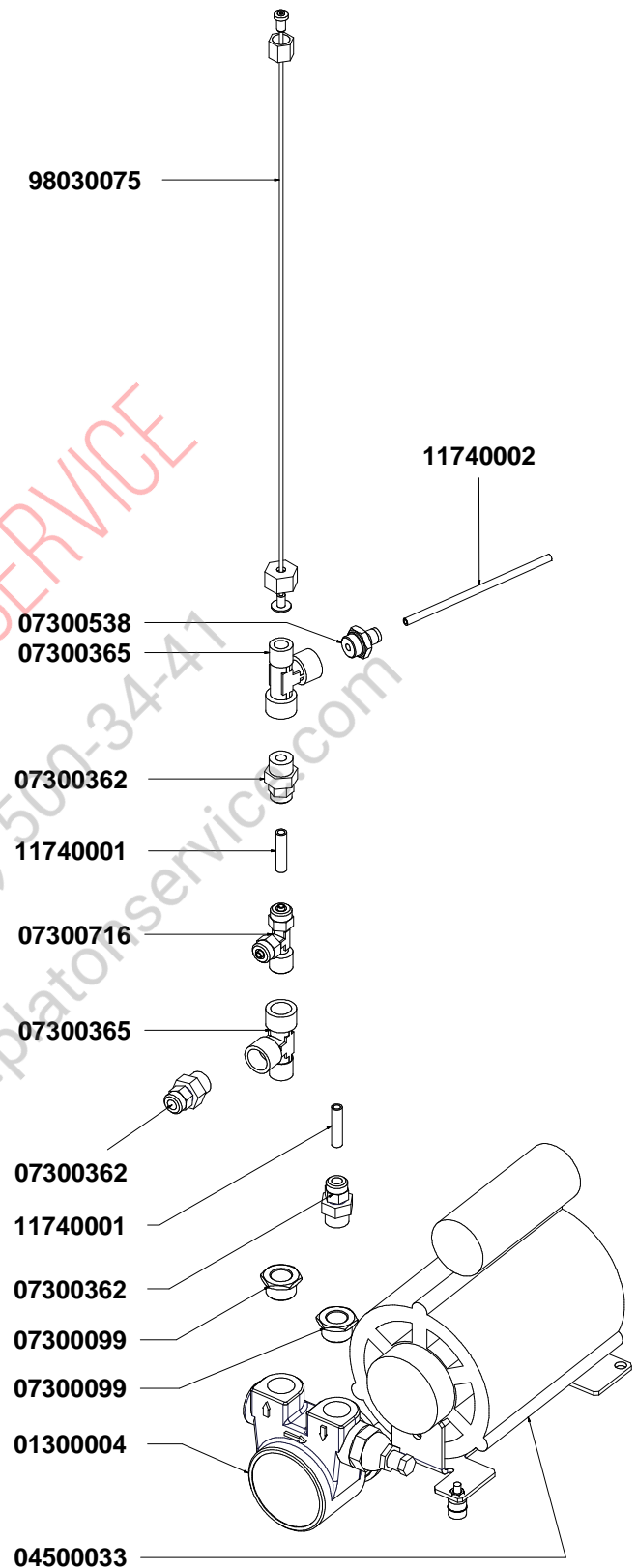
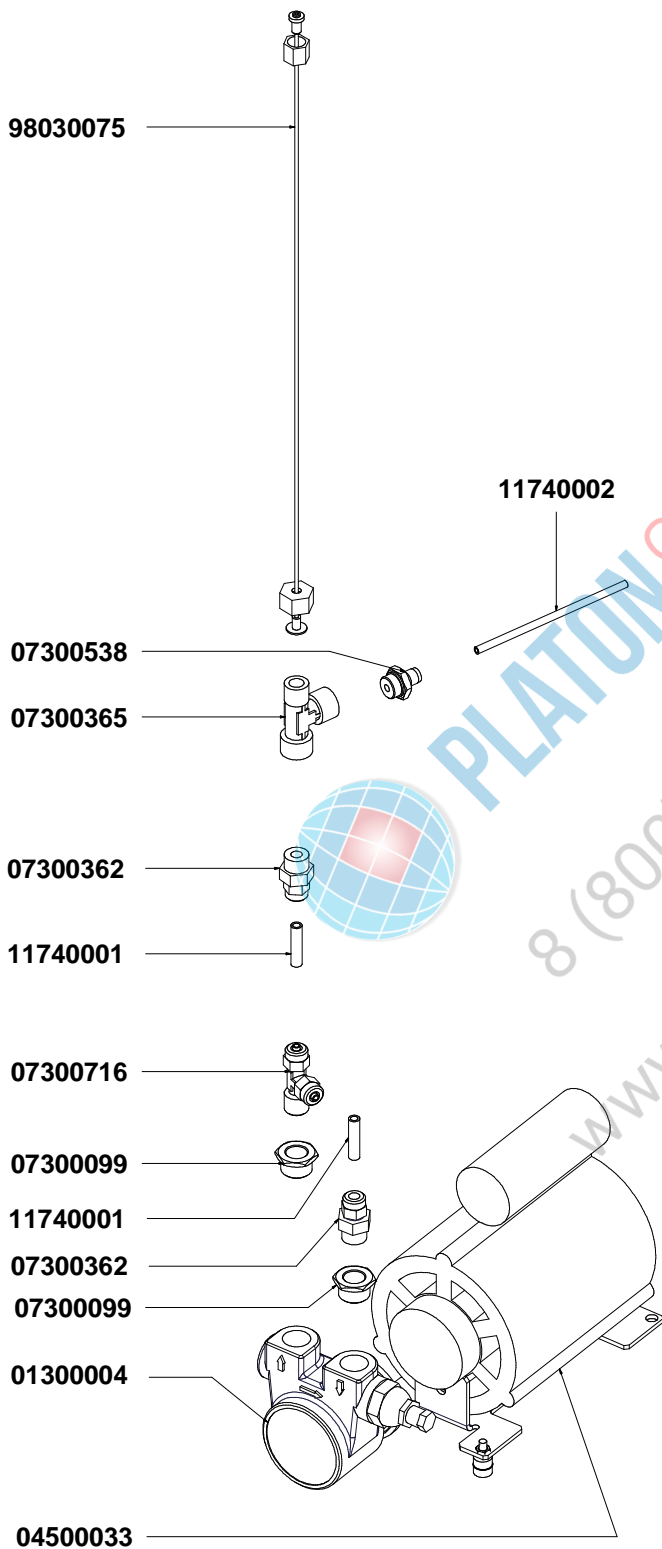

COMPONENTI IDRAULICI - VERSIONE STANDARD

HYDRAULIC COMPONENTS - STANDARD VERSION

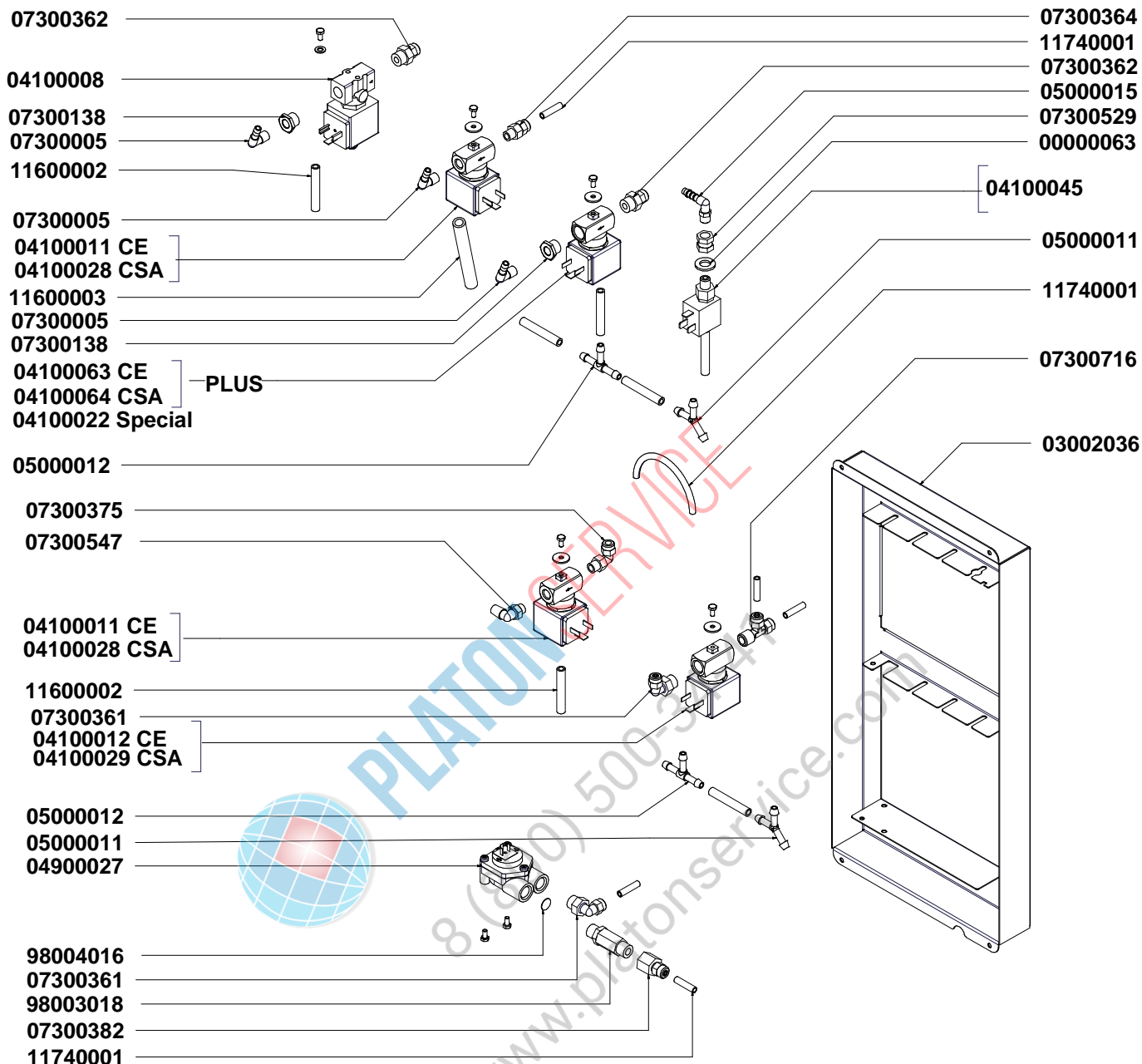

98210000000180000

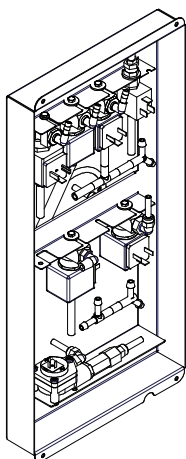

98210000000850000

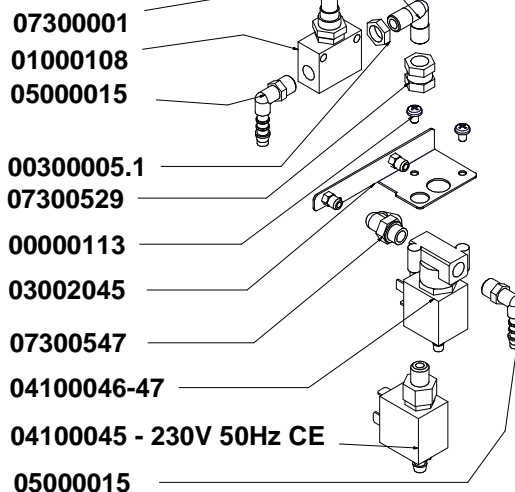

COMPONENTI IDRAULICI - VERSIONE CON MISCELATORE

HYDRAULIC COMPONENTS - ECONOMIZER VERSION

T
A
L
E
N
T
O

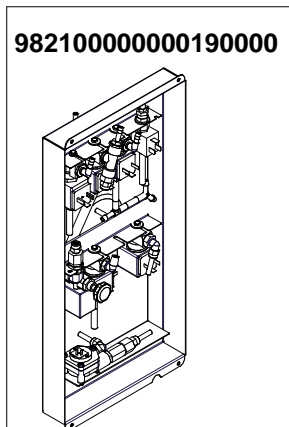
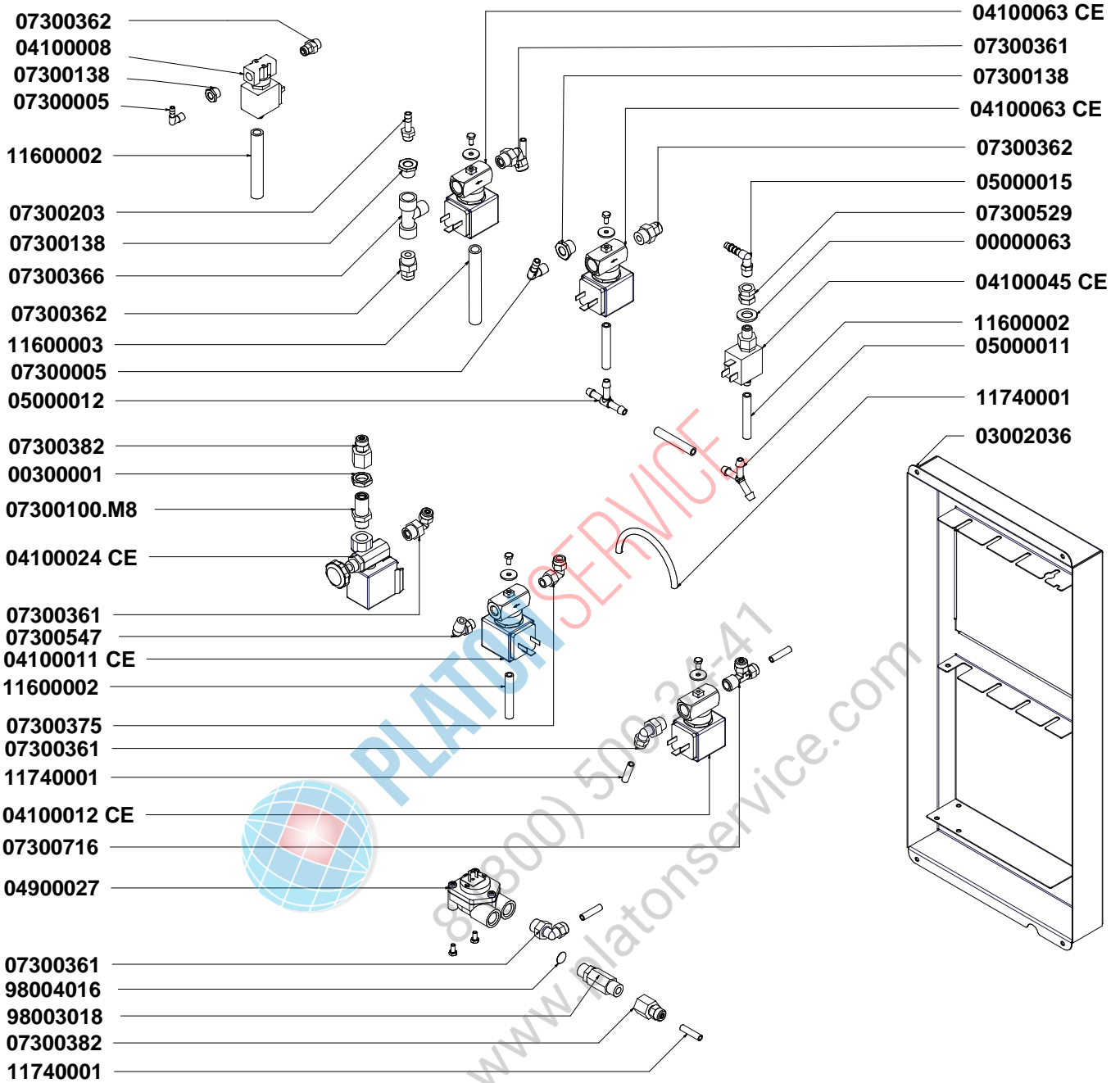

982100000000850000

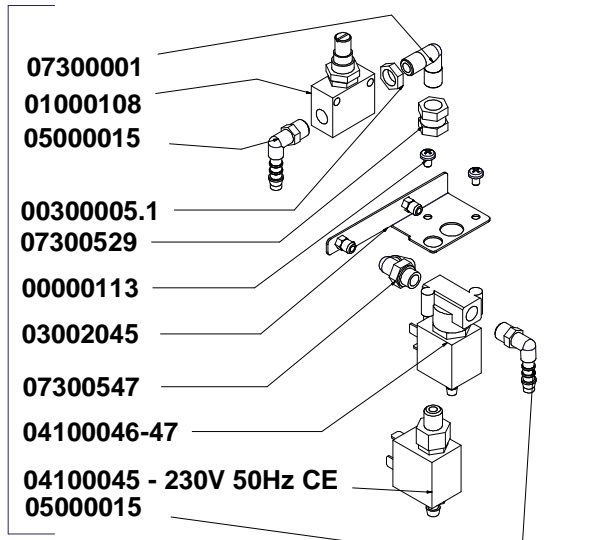

COMPONENTI GRUPPO EROGAZIONE

DELIVERY GROUP COMPONENTS

T
A
L
E
N
T
O

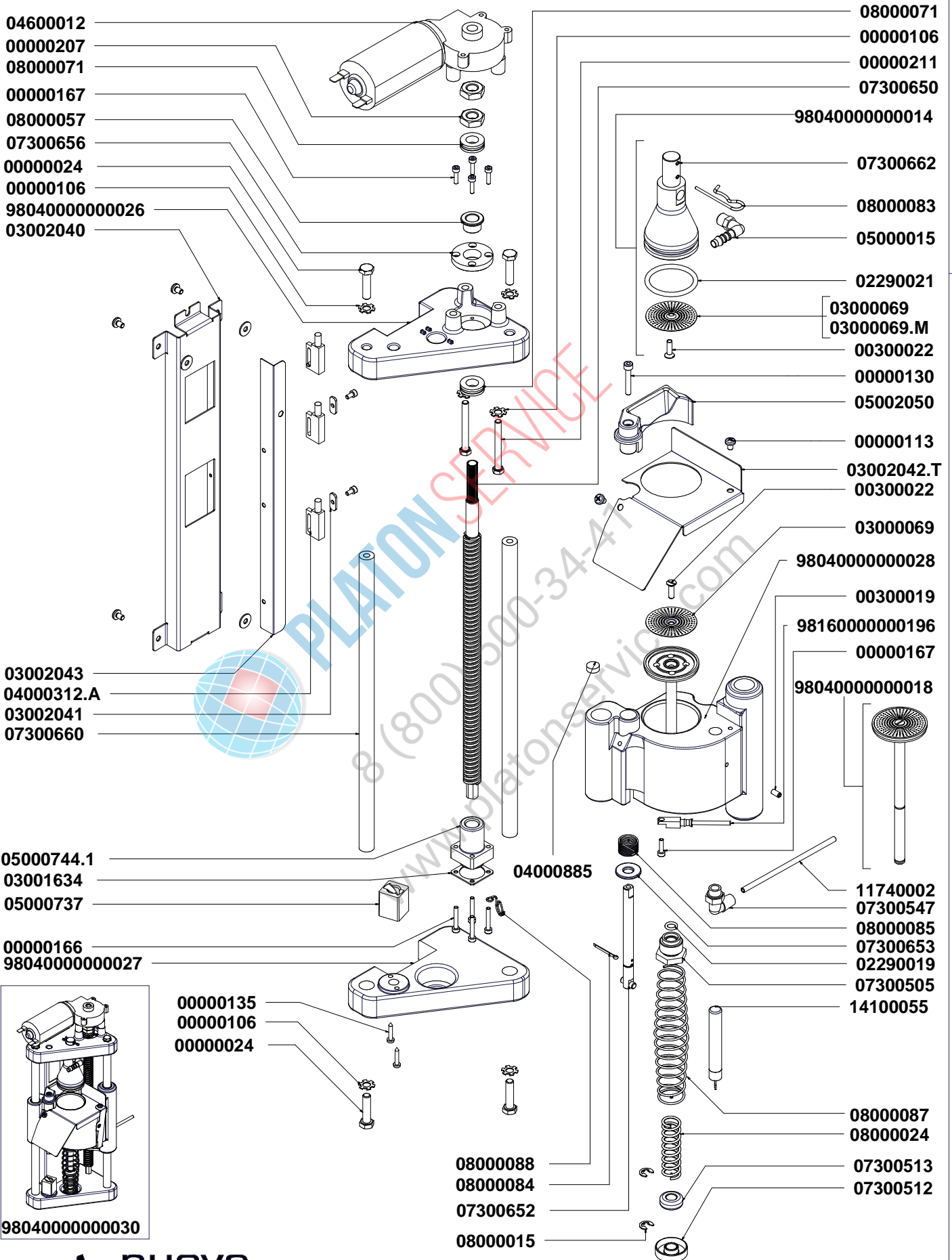

COMPONENTI GRUPPO CALDAIE

BOILERS COMPONENTS

98030000000870000

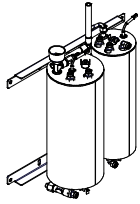

98030000000810000 CAFFE' - COFFEE
98030000000850000 VAPORE - STEAM

03000004 - CSA
09500011 - CSA

08000025
04900775
01000023

03000202
98120002 6.5bar

07300138
07300365

04000908-CSA
00300002.1

07300362
07300362
03002011

07300319
40000010

03002011
01000178
98030362
02290030.1
14100088

VERSIONE CON MISCELATORE
ECONOMIZER VERSION

98030364
07300714

VERSIONE STANDARD
STANDARD VERSION

07300129

07300009
07300063

01000180
09000005.1
03000004-CSA
09500001-CSA
01000176

48000010
07300147
98120001 16.5bar
04900775.1

07300128] VERSIONE CON MISCELATORE
ECONOMIZER VERSION

07300362] VERSIONE STANDARD
STANDARD VERSION

07300362
07300361

04000908-CSA
01000174
98030360

02290030.1
14100088

09500016 (184°C)
09500014 (167°C)-CSA

00300002.1

07300361
07300121
07300063
07300009

09500015 (184°C) CSA
09500016 (184°C)

00300002.1

07300116

07300362

COMPONENTI ELETTRICI ELECTRICAL COMPONENTS

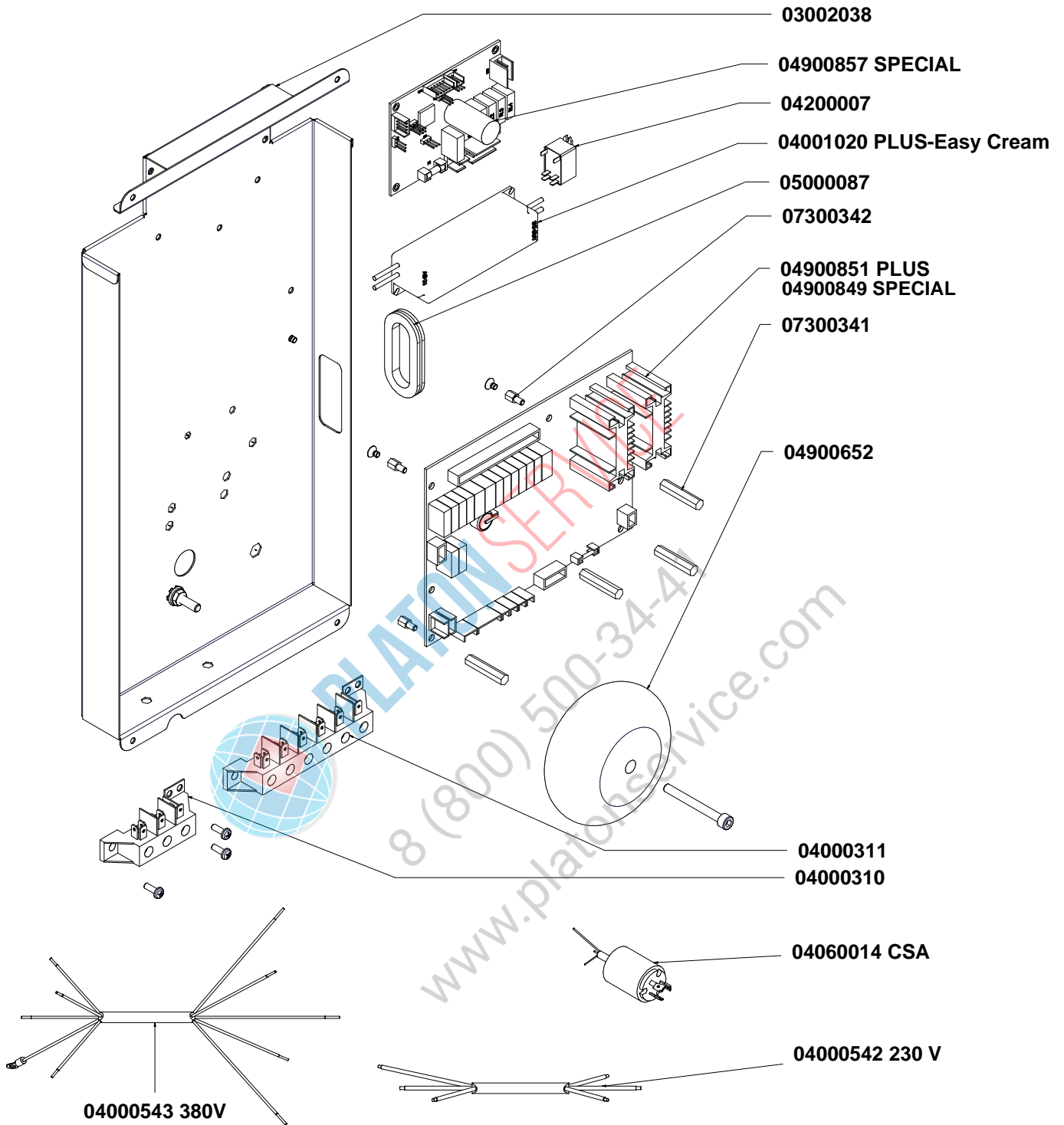

CODICE	FINE VALIDITA' VALIDITY END	DESCRIZIONE	DESCRIPTION
04000890		Impianto elettrico	Electric wiring
04000889		Cavo pulsantiera-centralina	Push button panel-junction box cable
04000888		Cablaggio motoriduttore	Electric motor cable
04000907		Cavo di terra L=130cm	Earthing cable L=130cm
04000887		Cablaggio sensori campane	Bells sensors cable
04000911		Supplemento cablaggio Special	Additional electrical wiring Special
98160000000091		assieme trasformatore + cablaggio talento plus con easy cream	transformer with + talent cabling easier with cream

CODICE	DESCRIZIONE	DESCRIPTION	END VALIDITY
00000024	VITE AQ M6x25 TE	HEX-HEAD SCREW M6x25	
00000050	VITE AUTOF 3,5x12 TC/T.CR. TRUCIOLARE	SCREW 3,5x12 TC/T.CR.	
00000060	DADO AQ M3 MEDIO ZINCATO	NUT M3 MEDIUM GALVANISED NUT	
00000063	RONDELLA AQ D 10X21X2 ZN	WASHER AQ D 10X21X2 ZN	
00000070	FASCETTA SGT 50/70 9 W4	SGT CLIP 50/70 9 W2	
00000106	RONDELLA ZIGRINATA DIAM 6	MILLED WASHER DIAM. 6	
00000113	VITE INOX M4x6 TC T.CR. 7985	SS CROSSHEAD CAP SCREW M4x6	
00000118	VITE INOX M4x12 TCEI 5931	SS HEX SOCKET CAP SCREW M4x12	
00000130	VITE INOX M4x25 TCEI UNI 5931	SS HEX SOCKET CAP SCREW M4x25	
00000133	FASCETTA INOX WD12 16-25 C7 W2	STAINLESS STEEL GIRDLE WD12 16-25 C7 W2	
00000134	VITE AQ M3x6 TC TC ZINC. UNI 6107	SCREW AQ M3x6 TC TC ZINC. UNI 6107	
00000135	VITE AUTOF 2,9x15 TCTC ZIN.	GALV. SLOTTED CAP SELF-TAPPIN SCREW 2,9x15	
00000150	VITE INOX M4x6 TBEI ISO 7380	STAINLESS STEEL M4x6 TBEI ISO 7380	
00000164	VITE INOX M3x16 TCEI ISO 4762	STAINLESS STEEL SCREW M3x16 TCEI ISO 4762	
00000165	VITE INOX M3x8 TCEI ISO 4762	STAINLESS STEEL SCREW M3x8 TCEI ISO 4762	
00000166	VITE INOX M3x20 TCEI ISO 4762	STAINLESS STEEL SCREW M3x20 TCEI ISO 4762	
00000167	VITE INOX M3x12 TCEI ISO 4762	STAINLESS STEEL SCREW M3x12 TCEI ISO 4762	
00000170	VITE INOX M4x12 TBEI ISO 7380	SS BUTTON HEAD HEX SOCKET SCREW M4X12 ISO 7380	
00000202	VITE AUTOF 4,1x12,9 TLARGA TCR NERA	SELF-TAPPING CROSS HEAD WIDE BLACK SCREW 4.1x12.9	
00000207	DADO AQ M10x1,25 BASSO ZINC.	LOW. ZINC AQ NUT M10x1.25	
00000210	RONDELLA AQ M3 ZIGRINATA UNI 8842/A	STAINLESS STEEL KNURLED WASHER D3	
00000211	VITE INOX M5x45 TE UNI 5739	SS HEX SCREW 5X45 UNI5739	
00300001	DADO OT 1/4 GAS SPESS.5 CH18 *AGG. 22.07.96	BRASS NUT 1/4 GAS SPESSOR 5	
00300002.1	00300002.1 DADO OT 1-4 GAS MAGGIORATO 0.3mm SPESS.3 CH18	BRASS NUT 1/4 SPESSOR 3	
00300005	DADO OT 1/8 GAS AGG.22.07.96 SPESS.4 CH13	BRASS NUT 1/8 GAS SPESSOR 4	
00300005.1	DADO OT 1/8 GAS MAGGIORATO 0.15mm SPESS.4 CH13	BRASS NUT 1/8 GAS 0.15mm	
00300017	DADO AUTOBLOC INOX M4 ALTO DIN982	SELF-LOCKING STAINLESS STEEL NUT M4 HIGH DIN 982	
00300019	GRANO INOX M4X6 UNI 5923	STAINLESS STEEL DOWEL M4X8 5923	
00300022	VITE INOX M4x14 TSP TC DIN963	INOX SCREW M4X14 TSP TC DIN963	
01000015	SERRATURA INVOLUCRO COMANDI	CONTROL BOARD DOOR LOCK	
01000023	VALVOLINA SFIATO	ANTI VACUUM VALVE	
01000052	CALAMITA RPV 14	MAGNET RPV 14	
01000072	ANTIVIBRANTE AD 10x10 M4 MM	ANTI-VIBRATING AD 10X10 M4 MM	
01000080	TUBO SCARICO FONDI SPIRAL.D.60	SPIRAL PIPES FOR DREGS DRAIN PIPE D. 60	
01000087	TUBO SCARICO 18x24,4	DRAINING TUBE 18x24,4	
01000088	TUBO VENTILAZIONE SPIRAL. D.30	SPIRAL VENT PIPE D. 30 COILS 30 m	
01000092	TUBO CARICO ACQUA 1,5mt EPDM 3/8F OTT. - 3/4F90°	3/8F-3/4F90° WATER CHARGE PIPE 1,5mt	
01000107	SILENZIATORE 1/8 491	SILENCER 1/8 491	
01000108	RUBINETTO MRF 1/8 F-F 604	TAP 1/8 F-F	
01000120	CAPPUCCINATORE	NSF MILK FOAMER FOR MICROBAR	
01000124	FILTRO NYLON 200µm TALENTO CMK	NYLON FILTER TALENTO CMK	
01000162	SCROCCHETTO COMPL. MICROBAR	MICROBAR LOCK COMPLETE BCT-40	
01000174	ISOLANTE CALDAIA CAFFE' D.90 270x294	COFFEE BOILER INSULATOR D.90 270x294	
01000176	ISOLANTE D.90 CALDAIA CAFFE'	COFFEE BOILER INSULATOR D.90	
01000178	ISOLANTE CALDAIA VAPORE D.115 270x369	COFFEE BOILER INSULATOR D.115 270x369	
01000180	ISOLANTE D.115 CALDAIA VAPORE	STEAM BOILER INSULATOR D.115	
01000190	ANTIVIBRANTE 15x30 M4 FF	VIBRATION DAMPER 15x30 M4 FF	
01000192	BASE CERNIERA PORTA "TALENTO" (SALICE)	HINGE SUPPORT BASE WILLOW "TALENTO"	
01000193	CERNIERA PORTA "TALENTO" (SALICE)	HINGE SUPPORT WILLOW "TALENTO"	
01000195	PRESSORE A MOLLA D.8 TALENTO	SPRING SPHERE	
01100016	MACINACAFFE' COMPLETO REG. DX TALENTO N.S.	GRINDER FOR TALENTO RIGHT	
01100017	MACINACAFFE' COMPLETO REG. SX TALENTO N.S.	GRINDER FOR TALENTO LEFT	
01100028	COPIA MACINE D.63,5 MACININO TALENTO N.S.	PAIR GRINDERS D 63.5 FOR TALENTO GRINDER	
01300004	POMPANTE VOLUMETRICO 50 lt/h	VOLUMETRIC PUMP 50 lt/h	
02000005	OR SUP. CAPPUC. MICROBAR SILICONE ROSSO	UPPER GASKET FOR MICROBAR CAPPUCCINO MAKER	
02000006	OR INF. CAPPUC. MICROBAR	LOWER GASKET FOR MICROBAR CAPPUCCINO MAKER	
02280017	GUARN. OR R3062/AN12 D21 EP851	ORING GASKET R3062/AN12 D21 EP851	
02280036	GUARN. OR x BECCO LANCIA VAP. D.10 EPDM70	GASKET OR x STEAM WAND NOZZLE	
02290019	GUARNIZIONE OR R6 DF801 VITON	GASKET O-RING LOWER PISTON OR R6 DF801	
02290030.1	GUARN.OR 147 D.50 NBR NERO	GASKET OR 147 D.50 NBR BLACK	
02290021	GUARN. OR 140/4137 D.41.5 SILICONE ROSSO Sh70	GASKET O-RING 140/4137 D.41.5 SILICON RED Sh70	
02600002	GUARNIZ. TEFLON RESISTENZA	TEFLON GASKET FOR HEAT. ELEMEN	
03000004	STAFFA SINGOLA x TERMOSTATO	STEEL HOLDER FASTOM FOR TERMOSTAT	
03000069	DOCCIA INOX D.40 x M4 T.SVP AGG.08.01.99	STAINLESS SPOUT D.40	
03000069.M	DOCCIA INOX D.40 x M4 T.SVP MICROFORI 0.25mm	SS SHOWER D. 40 X M4 COUNTERSUNK WITH MICRO-OPENINGS 0.3 mm	
03000202	VASCHETTA RACC.CONDENSE MASTERAGG. 07.06.97	CONDENSATION TRAY MASTER	
03001634	PIASTRINA FISSAGGIO CHIOCCIOLA VITE GRUPPO MICROBAR	FASTENING PLATE FOR MICROBAR GROUP SCREW VOLUTE	
03001765	RETINA PIANO LAVORO 1 GR.	WORKTOP NET 1 GR.	
03001771	PIATTO RACCOGLIACQUA 1 GR	DRIP TRAY	
03002002	BASE TELAIO TALENTO	FRAME BASE TALENTO	
03002004	FIANCO TELAIO DX TALENTO	RIGHT SIDE FRAME TALENTO	
03002006	FIANCO TELAIO SX TALENTO	LEFT SIDE FRAME TALENTO	
03002008	LAMIERA SUPP. GRUPPO TALENTO	GROUP SUPPORT PANEL TALENTO	
03002009.F	LAMIERA SUPP.CASSETTO FONDI TALENTO	DREGS TRAY SUPPORT PANEL WITH DRAIN HOLE D. TALENTO	
03002010	LAMIERA SUP.MACININI TALENTO	GRINDER SUPPORT PANEL TALENTO	
03002011	STAFFA SUPP. CALDAIE TALENTO	BOILER SUPPORT BRACKET TALENTO	
03002012	LAMIERA SUPP.VENTOLE TALENTO	FAN SUPPORT PANEL TALENTO	
03002014	PORTA FRONTALE RIVETTATA TALENTO	FRONT HATCH RIVETED TALENTO	
03002018	CHIUSURA PORTA FRONTALE DX TALENTO	RH FRONT HATCH CLOSURE TALENTO	
03002020	FIANCO INOX DX TALENTO	SS RIGHT HAND SIDE PANEL TALENTO	
03002022	FIANCO INOX SX TALENTO	SS LEFT HAND SIDE PANEL TALENTO	
03002024	RETRO INOX TALENTO	STAINLESS STEEL BACK TALENTO	
03002027	VASCHETTA RACCOGLIPOLVERE TALENTO	DUST TRAY TALENTO	
03002028	PIANO CHIUSURA SUPERIORE TALENTO	TOP COVER PANEL TALENTO	
03002029	CARTER COPRIMOTORE TALENTO	MOTOR POURING GROUP CASE - TALENTO	
03002030	LAMIERA FISSAGGIO GHIGLIOTTINA CAMPANA TALENTO	BELL GUILLOTINE FASTENING PANEL TALENTO	
03002031	GHIGLIOTTINA CAMPANA TALENTO	BELL GUILLOTINE TALENTO	
03002034	PIASTRINA SERRATURA TALENTO	LOCK PLATE TALENTO	
03002036	SUPPORTO ELETTROV. TALENTO	SOLENOID VALVE SUPPORT TALENTO	
03002038	SUPPORTO CENTRALINA TALENTO	CONTROL BOARD SUPPORT TALENTO	
03002040	LAMIERINO RETRO GRUPPO TALENTO	GROUP REAR LAMINATION TALENTO	
03002041	LAMIERINO BLOCCA SENSORE TALENTO	SENSOR LOCK LAMINATION TALENTO	
03002042.T	LAMIERA GR.TEFLONATA TALENTO	TEFLON-COATED GROUP PANEL TALENTO	
03002043	LAMIERINO COPRI SENSORI GRUPPOTALENTO	GROUP SENSOR COVER LAMINATION TALENTO	
03002045	SUPPORTO EV ARIA + EV PULIZIA TALENTO	CLEANING VALVE SUPPORT TALENTO	

T A L E N T O

CODICE	DESCRIZIONE	DESCRIPTION	END VALIDITY
03002045	SUPPORTO EV ARIA + EV PULIZIA TALENTO	CLEANING VALVE SUPPORT TALENTO	
03002047	SICUREZZA CAMPANA TALENTO INOX	SS BELL SAFETY TALENTO	
03002050	IMBUTO SCARICO DIRETTO TALENTO	DIRECT WASTE FUNNEL TALENTO	
03002051	PROTEZIONE CONNETTORE GRUPPO TALENTO	PROTECTION POURING GROUP TALENTO CONNETTOR	
03002052	SUPPORTO VITE S.F. MACININO TALENTO	GRINDER ADJUSTMENT SCREW SUPPORT	
03002058	USCITA INOX CAFFE' MACININO TALENTO	GRINDER CHUTE TALENTO	
03002059	MOLLA LAMIERINO USCITA CAFFE' MACININO TALENTO	GRINDER CHUTE FLAP TALENTO	
03002061	CLUMP CRUSHER TALENTO	CLUMP CRUSHER TALENTO	
03002093	LAMIERINO CHIUSURA SMART CARD TALENTO	TOUCHPAD PANEL HOLLE COVER	
03002097	LAMIERA FISS. BECCO + PRESA	SS SUPPORT PURING SPOUT COVER	
03002098	PIASTRINA FISSAGGIO REGISTRO LANCIA TALENTO		
03002122	STAFFA SUPP. POMPA LATTE PER MONTALATTE TALENTO	MILK PUMP CLUMP	
03002300	GRIGLIA METALLICA x VENTILAT. 60x60 GM60	METAL GRILLE FOR FAN GM60	
04000310	MORSETTIERA A VITE FV110 220V.	SCREW TERMINAL FV110 220 V	
04000311	MORSETTIERA A VITE FV122 380V TRIFASE+NEUTRO 6 POLI	SCREW TERMINAL 380 V	
04000312.A	SENSORE MAGNETICO L=400	MAGNETIC SENSOR L400	
04000313	UNITA' MAGNETICA M 305 AA	MAGNETIC UNIT M 305 AA	
04000315	UNITA' MAGNETICA D10x6	MAGNETIC UNIT D10x6	
04000884	UNITA' MAGNETICA 10x3 FERRITE	MAGNETIC UNIT D10x3	
04000885	UNITA' MAGNETICA 10x6 FERRITE	MAGNETIC UNIT D10x6	
04000887	CABLAGGIO SENSORI CAMPANE + RACCORDO DECA TALENTO	BELLS SENSOR WIRING TALENTO	
04000888	CABLAGGIO MOTORIDUTT. TALENTO	GEAR MOTOR WIRING TALENTO	
04000889	CAVETTO CONNES. SCHEDA TAST. -SCHEDA I/O "TALENTO"	WIRE TO CONNECT "TALENTO" TOUCHPAD-CONTROL BOARD	
04000890	IMPIANTO ELETTRICO TALENTO	WIRING TALENTO	
04000891	VENTOLA 24V 0,08A DC 60x60x25	24 V DC 60x60x25 FAN 0.08A	
04000892	VENTOLA 24V 0,15A DC 60x60x25	24 V DC 60x60x25 FAN 0.15A	
04000893	CAVO PROLUNGA AUTOSTEAM TALENTO M-F	EXTENSION CABLE AUTOSTEAM TALENTO	
04000899	CAVO CONNES. SCHEDA TAST.- SCHEDA ILLUMINAZ. TALENTO	BOARD-PANEL LIGHTING CONNECTING CABLE - TALENTO	
04000907	CAVO TERRA L130 CON OCCHIELLO D6 TALENTO	EARTH WIRE L130 1 SLOTS D6	
04000908	CAVO TERMOSTATO CALDAIA TALENTO VERSIONE CSA	BOILER THERMOSTAT/CABLE - TALENTO CSA VERSION	
04000911	SUPPLEMENTO CABLAGGIO TALENTO CMK	ADDITIONAL TALENTO WIRING	
04001020	TRASF.CENTRALINA IN 90/264 VACOUT:24 VDC LPV 20-24	TRANSFORMER IN 90/264 VACOUT:24 VDC LPV 20-24	
04100008	E.V. NC 3VIE 1/4-1/4 SCAR. 1/8220V 50Hz-240V 60Hz RUBY F3 UL	NC 3-WAY SOLENOID 1/4-1/4 1/8 OUTLET	
04100011	E.V. NC 3VIE 1/8-1/8 SCAR. 1/8220-230V 50/60Hz VITON F1.3 CE	SOLENOID VALVE	
04100012	E.V. NC 2VIE 1/4-1/4 220-230V 50/60HZ VITON F1.5 CE	EV 2W 1/4 1/4 220-230V 50/60HZ VITON F1,5 CE	
04100017	E.V. NC 3VIE BASETTA SCAR. 1/8208-240V 60Hz RUBY F1.5 CE	EV 3W DOWNL.1/8 220-230V 50/60HZ RUBY F1,5 CE	
04100022	E.V. NC 2VIE 1/4-1/4 220-230V 50/60Hz RUBINO F3 CE	2 WAYS SOLENOID 1/4 F.3 220/230V 50/60Hz	
04100024	E.V. NC 2VIE 1/4 REGOLAT. 90° 230V 50/60Hz F.3 + MANOP. EPDM	2 WAYS EV WITH REGULATOR	
04100027	E.V. NC 3VIE BASETTA SCAR. 1/8208-240V 60Hz RUBY F1.3 UL	EV 3W DRAIN 1/8 208-240V 60Hz RUBY D1,3 UL	
04100028	E.V. NC 3VIE 1/8-1/8 SCAR. 1/8208-240V 60Hz RUBY F1.3 UL	E.V. EROGAZ. MASTER APPROV UL	
04100029	E.V. NC 2VIE 1/4-1/4 208-240V 60Hz VITON F1.5 UL	E.V. 2VIE AL 220/240 50/60 UL	
04100045	E.V. NC 2VIE 1/8M-PORTAGOMMA 230V 50/60Hz VITON F1.7 CE	2-WAY SOLENOID 1/8 M HOSE SUPPORT	
04100046	E.V. NC 3VIE 1/8-1/8 PORTAG. 230V 50/60Hz VITON F1.5 CE	ELECTR. 3-WAY 1/8" F1.5 230V 50/60Hz HOSE CLAMP OUTLET	
04100047	E.V. NC 3VIE 1/8-1/8 PORTAG. 115V 60Hz VITON F1.5 UL	ELECTR. 3-WAY 1/8" F1.5 115V 60Hz HOSE CLAMP OUTLET	
04100050	E.V. NC 2VIE 1/8-PORTAG. 90° 230V 50/60Hz VITON F2 CE	ELECTROVALVE 2 WAYS 1/8 F2 23050-60 Hz	
04100060	E.V. NC 2VIE 3/4-JG 6 DIRITTA REGOL+FILTR F.2,5 230V 50/60Hz	2-WAY SOLENOID VALVE 3/4-JG 6 230V 50/60Hz	
04100062	E.V. NC 2VIE 3/4-JG 6 DIRITTA REGOL+FILTR F.2,5 208/240V60Hz	2-WAY SOLENOID VALVE 3/4-JG 6 230V 60Hz UL	
04100063	E.V. NC 3VIE 1/4-1/4 SCAR. 1/8230V 50Hz VITON F2.5 CE	3-WAY SOLENOID 1/4-1/4 1/8 OUTLET F.2,5	
04100064	E.V. NC 3VIE 1/4-1/4 SCAR. 1/8208-240V 60Hz VITON F2.5 UL	3-WAY SOLENOID 1/4-1/4 1/8 OUTLET F.2,5 UL	
04100067	E.V. NC 3VIE 1/8-1/8 PORTAG.UL 208/240V 60Hz VITON F1.5 V0	NC 3-WAY SOLENOID 1/8-1/8 HOSE SUPPORT 208-240V 60Hz VITON F1	
04200007	RELE' DI POTENZA 30A 230 V BOPOLARE	POWER RELAY 30A 230 V BIPOLAR	
04200063	MICROSWITCH PORTA	DOOR MICROSWITCH	
04500033	MOTORE EL. MASTER/PREMIER 2001230V 50/60Hz 120W	PUMP MOTOR MASTER/PREMIER 2001 230V 50/60Hz	
04500056	MOTORE ELETTRICO 230V 50/60Hz 245W MACININO TALENTO N.S.	230V 50/60Hz 245W ELECTRIC MOTOR FOR GRINDER - TALENTO N.S.	
04500058	CONDENSATORE PER MOTORE MACININO TALENTO N.S.	CONDENSER FOR GRINDER MOTOR - TALENTO N.S.	
04600012	MOTORIDUTTORE 24V TALENTO	GEAR MOTOR 24V GMGP 404.157 DN.43	
04600020	MICROCOMPRESSORE "TALENTO CMK"	MICROCOMPRESSOR "TALENTO CMK"	
04900027	DOSATORE VOLUMETRICO OTT.	FLOWMETER	
04900652	TRASF. COMPL.MICROBAR 230V/18V 150VA 50/60Hz FUSE750mA	COMPLETE TRANSFORMER 230V-18 150VA 50/60Hz FUSE750m	
04900777	PULSANT. LEGENDABILE TALENTO COLORE BIANCO	TOUCH PAD WITH KEY TALENTO -COLOR WHITE	
04900778	PULSANTIERA LEGENDABILE "TALENTO"	TOUCH PAD WITH KEY TALENTO	
04900779	SCHEDA ILLUMINAZIONE PANNELLO LED SMD TALENTO	PANEL LIGHTING CARD TALENTO	
04900780	SONDA PT1000 x LANCIA VAPORE "TURBO CREAM" D06 + SUPP	PROBE PT1000 X STEAM WAND "TURBO CREAM" D06	
04900849	SCHEDA CPU I/O POTENZA TALENTO CMK	CPU BOARD I/O POWER TALENTO CMK	
04900851	SCHEDA CPU I/O POTENZA TALENTO 2011 Rel. 4.16	POWER CARD TALENTO 2011	
04900855	SCHEDA CPU TASTIERA + DISPLAY GRAFICO TALENTO 2011 Rel	DISPLAY BOARD TALENTO 2011	
04900856	SCHEDA CPU TASTIERA + DISPLAY GRAFICO TALENTO CMK	TOUCH PAD CPU BOARD+ DISPLAY TALENTO CMK	
04900857	CENTRALINA CONTROLLO POMPA TALENTO CMK	PUMP CONTROL BOARD TALENTO CMK	
05000001	GOMMINO PROTEZIONE LANCIA D.10	STEAM ARM RUBBER GRIP	
05000011	RACCORDO PORTATUBO YS 6	YS 6 HOSE FASTENING	
05000012	RACCORDO PORTATUBO TS 6	TS 6 HOSE FASTENING	
05000015	RACCORDO PORTATUBO WES 6R 1/8	WES 6R 1/8 HOSE FASTENING	
05000031	ANELLO REGOLAZ. CAPPUCINATORE	MILK-FOAMER REGULATION RING	
05000032	POMELLO FILETTATO	THREADED KNOB	
05000037	GHIERA FILETTATA PER PANNELLI M4 BIANCO	THREADED RING NUT FOR PANELS M4 WHITE	
05000085	PRESSACAVO TEC-S M20 D.7-14 CON DADO P-CT M20 Es24	CABLE GLAND TECH-S M20 D.7-14+ NUT P-CT M20	
05000086	PASSACAVO A MEMBRANA BIANCO	MEMBRANE CABLE DUCT	
05000087	PASSACAVO PVC OVALE NERO OV7	BLACK PVC GROMMET OVAL	
05000244	TAPPO COPRIFORO QUADRATO 25x25 NERO STQ 25x25	22 x 19 RECTANGULAR BLACK CAP TO COVER HOLE	
05000317	INIETTORE CAPPUCIN.SUPERAUT	INJECTOR SUPERAUT CAPPUCIN.	
05000737	BOCCOLA MOV. ESPULSIONE MICROBAR	MICROBAR UNIT EJECTION BUSHING	
05000744.1	CHIOCCIOLA VITE MOVIMENTO T.N.NYLON MICROBAR	MICROBAR VOLUTE MOVEMENT SCREW	
05000762	RACCORDO PORTATUBO GES 6 1/8 MASCHIO DIRITTO	STRAIGHT FITTING - PIPE HOLDER 1/8	
05000848	RACCORDO RAPIDO PASSAPARETE D4	D4 BULKHEAD SNAP-ON JOINT	
05000880	PROLUNGA PIEDE ALTO 2005 D.66 H=80 mm.	TALL FOOT EXTENSION D.66 H=80 MM.	
05002002	ATTACCO EROG. CAFFE' TALENTO PA6+FV30	COFFEE POURING FASTENING TALENTO PA6+FV30	
05002004	BECCO EROG. INTERNO TALENTO POM	INTERNAL POURING SPOUT TALENTO POM	
05002005	TAPPO BECCO EROG TALENTO POM	POURING SPOUT TALENTO POM	
05002006.N	COVER BECCO EROG. TALENTO NERO	POURING SPOUT COVER TALENTO BLACK	
05002008	FRIZIONE BECCO TALENTO PP	FRICTION TALENTO	
05002010	SLITTA BECCO TALENTO PA6+FV30	SPOUT SLIDE TALENTO PA6+FV30	
05002011	SUPPORTO A C TALENTO PA6+FV30	A C SUPPORT TALENTO PA6+FV30	
05002012	TELESCOPICO A TALENTO PP	TELESCOPIC A PP	
05002014	TELESCOPICO B TALENTO PP	TELESCOPIC B PP	
05002016	MANIGLIA PORTA TALENTO	DOOR HANDLE TALENTO	

T
A
L
E
N
T
O

CODICE	DESCRIZIONE	DESCRIPTION	END VALIDITY
05002020	ATTACCO SCARICO VASCHETTA TALENTO	TRAY WASTE FASTENING TALENTO	
05002024	CONVOGLIATORE DETERGENTE TALENTO	DETERGENT CONVEYOR TALENTO	
05002025	COPERCHIO CONVOGLIATORE TALENTO	CONVEYOR LID TALENTO	
05002028	COPERCHIO CAMPANA TALENTO	BELL LID TALENTO	
05002030	SCIVOLO CAFFE' TALENTO	COFFEE CHUTE TALENTO	
05002031	SCIVOLO CAFFE' TALENTO TAGLIATO	COFFEE CHUTE TALENTO (CUT)	
05002033	CHIUSURA SCIVOLO x MACININO N.S. TALENTO	GRINDER UPPER CONVEYER TALENTO	
05002040	SUPPORTO PULSANTIERA TALENTO	TOUCH PAD SUPPORT TALENTO	
05002042	LUMINOSA METACRILATO TALENTO	LIT METHACRYLATE TALENTO	
05002046	CORNICE PULSANTIERA TALENTO	TOUCH PAD FRAME TALENTO BLACK	
05002046.B	CORNICE PULSANTIERA TALENTO COLORE BIANCO RAL 9010	TOUCH PAD FRAME TALENTO WHITE	
05002050	PALETTA ESPULSIONE TALENTO	EJECTION PALETTE TALENTO	
05002052	PANNELLO VETRO SX PORTA SPESS.6 TALENTO	LH GLASS DOOR PANEL TH. 6 TALENTO	
05002058	ETICHETTE LEGENDABILI PULS. TALENTO N.38 BEVANDE+7 NEUTRI	KEY LEGEND DECALS - TALENTO	
05002072	CHIUSURA DX USCITA CAFFE' BECCO TALENTO	RIGHT GRINDER CHUTE	
05002074	CHIUSURA SX USCITA CAFFE' BECCO TALENTO	LEFT GRINDER CHUTE	
05002100	GRANO M5x10	GRUB SCREW M5x10	
05340020	PROTEZIONE x PRESA USB	USB PLUG PROTECTION	
06100087	TAZZA CONVOGLIATORE FINITO MACININO TALENTO	LOWER CONVOGYER - TALENTO GRINDER	
06100088	PORTAMACINA INFERIORE MACININO TALENTO	LOWER GRINDER HOLDER - TALENTO GRINDER	
06200120	BLOCCETTO PORTA EV. CAFFE' TALENTO	BRASS SUPPORT FOR SOLENOID VALVE	
07300001	RACCORDO L 1/8 M-M 459	L FITTING 1/8 M-M	
07300005	PORTAGOMMA ANG. 1/8 X 7 F1 4.8AGG. 18.06.96	ANGULAR HOSE CLAMP 1/8"	
07300009	DADO RACCORDO 1/4 GAS	NUT CONNECTION 1/4 GAS	
07300063	TERMINALE CHIUSO D 11	TERMINAL D 11 CLOSED	
07300099	RIDUZIONE 3/8 1/4 ES. 20 AGG. 29.05.96	VACUUM RELIEF VALVE ADAPTER	
07300100.M8	ATTACCO SCARICO 1/4 VAS. SCAR.CON OR + INT. M8	DOWNLOAD FASTENING 1/4 DOWNLOAD TRAY WITH OR	
07300116	RACCORDO T 1/4 M-M-F	JOINT T1/4 M-M-F 465	
07300121	RACCORDO L 1/4 M-M CILIN 459 AGG. 18.02.97	CONNECTION L 1/4 M-M CYLIN. 459	
07300128	TAPPO 1/4 GAS AGG.31.01.89	CAP 1/4 GAS	
07300129	TAPPO 1/8 GAS	CAP 1/8 GAS	
07300138	RIDUZIONE 1/4"- 1/8" ES. 17 AGG. 29.05.96	REDUCTION 1/4"-1/8" ES, 17 ADD. 29.05.96	
07300147	RACCORDO 1/4 F.7 1/8 F.5 M-M AGG. 18.06.97	REDUCTION 1/4 F.7-1/8 F.5 M-M AGG. 18.06.97	
07300203	PORTAGOMMA CIL. 7 1/8	CILINDRICAL HOSE CLAMP 1/8	
07300319	BOCCOLA CAVALLOTTO FULCRO LEVAAGG. 23.11.95	LEVER FULCRUM SLOT BUSHING ADD. 23.11.95	
07300341	PERNO BLOCC. CENTRAL. VIP INOXNICHELATO L=35	CENTRAL LOCK VIP NICKEL PLATED L=35	
07300342	PERNO SUPPORTO CENTRAL. VIP NICHELATO	NICKEL PLATED CONTROL UNIT SUPPORT PIN	
07300361	RACCORDO L GIR 6 1/4 VITON346A	PIVOTING CONNECTION L 6 1/4 VITON346A	
07300362	RACCORDO DIR.M.C.6 1/4 340	STRAIGHT FITTING 1/4	
07300364	RACCORDO DIR. M. CON.6 1/8 CALZ. 340	STRAIGHT FITTING 1/8 SHEATH TYPE D.6	
07300365	RACCORDO T 1/4 M-F-F	T FITTING 1/4 FFM	
07300366	RACCORDO T 1/4 F-M-F	CONNECTION T 1/4 F-M-F 462	
07300375	RACCORDO L GIR 6 1/8 VITON 346	L FITTING 1/8 VITON 346A	
07300382	RACCORDO DIR. F 1/4 - CALZAM.	CONNECTION DIR. F 1/4 !! ACTUATOR	
07300466	RACCORDO FILET. INOX x LANCIA VAPORE MAC/PROGRAM	STEAM WAND SS THREADED CONNECTION PROGRAM/MAC	
07300505	BOCCOLA ALBERO PISTONE SCARICO	MICROBAR DRAIN PISTON SHAFT BUSHING	
07300512	PIATTELLO PORTAMOLLA INFERIORE GR. MICROBAR	MICROBAR GROUP LOWER SPRING WASHER	
07300513	PIATTELLO PORTAMOLLA SUPERIORE GR. MICROBAR	MICROBAR GROUP UPPER SPRING WASHER	
07300529	MANICOTTO FILETTATO 1/8 450	THREADED SLEEVE 1/8	
07300538	RACCORDO RAPIDO 1/4 DIRITTO D4	QUICK COUPLING 1/4 STRAIGHT D4RACCORDO RAPIDO 1/4 DIRITTO D4	
07300539	RACCORDO RAPIDO 1/8 DIRITTO D4	QUICK COUPLING 1/8 STRAIGHT D4	
07300542	RACCORDO RAPIDO M6 L GIR. D4	L FITTING QUICK COUPLING M6 L SWIVEL D4	
07300547	RACCORDO RAPIDO 1/8 L GIR. D4	1/8 L GIR. D4 SNAP-ON COUPLING	
07300607	PERNO FISSAGGIO CARENE M6-L.2 NICHELATO APPIA	FIXING HINGE M6 L.2	
07300617	PORTAGOMMA INNESTABILE D4 OTT FORO 3mm	BRASS HOSE CLAMP D4	
07300619	INSERTO PROLUNGA PIEDE ALTO ES 20 L=70 + M10	INSERTION EXTENSION TALL FOOT ES 20 L=70 M10	
07300627	ATTACCO INOX D.10 AUTOSTEAM M-M 8.65x0.75	AUTOSTEAM FITTING M-M 8,65X0,75	
07300629	TUBO LANCIA INOX VAPORE L=142 EASYCREAM TALENTO	EASYCREAM SS STEAM WAND L=142 TALENTO	
07300650	VITE MOVIMENTO GR. "TALENTO"	GROUP MOVEMENT SCREW TALENTO	
07300652	ALBERO PALETTA TALENTO	EJECTION BLADE SHAFT TALENTO	
07300653	RONDELLA OT D.20x8.1xS.2	BRASS WASHER D.20x8.1xTh.2	
07300656	BOCCOLA FLANGIATA GR TALENTO	GR FLANGED BUSHING TALENTO	
07300660	COLONNA D.12 GR TALENTO	GR COLUMN D 12 TALENTO	
07300661	COLONNA D.8 GUIDA BECCO EROG. TALENTO	POURING SPOUT GUIDE COLUMN D. 8 TALENTO	
07300662	PISTONE EROG. SUP. TALENTO RESINA ACETALICA	TALENTO TOP POURING PISTON ACETALIC RESIN	
07300664	ATTACCO INOX LANCIA TALENTO	WAND SS FASTENING TALENTO	
07300665	COPRIFORO SONDA AUTOSTEAM	AUTOSTEAM PROBE HOLE COVER	
07300666	BASETTA INOX ATTACCO LANCIA TALENTO	WAND FASTENING SS BASE TALENTO	
07300673	REGISTRO LANCIA TALENTO	WAND ADJUSTER - TALENTO	
07300668	BECCO ACQUA D.10 INOX	SS WATER NOZZLE D.10	
75006038.1	BECCO VAPORE INOX ES 12 F1-2	SS STEAM NOZZLE	
07300671	BECCO EASYCREAM TALENTO	TALENTO EASYCREAM NOZZLE	
07300672	PROLUNGA FISSAGGIO SCALDATAZZE TALENTO	TALENTO CUP WARMER FASTENING EXTENSIONS	
07300674	PROLUNGA FISSAGGIO SUPPORTO BECCO EROGAZIONE	POURING SPOUT SUPPORT FASTENING EXTENSION	
07300678	DISTANZIALE D.6 H.8 FORO 3.5	SHIM D.6 H.8 HOLE 3.5	
07300714	RACCORDO L 1/8 M - CALZAM.6	L FITTING 1/8 SHEAT	
07300822	UGELLO BECCO CAPPUCINATORE TALENTO CMK	NOZZLE DIFFUSER TALENTO CMK	
07300824	MIXER CAPPUCINATORE TALENTO CMK	MILK FROTHER MIXER TALENTO CMK	
07300826	TERMINALE COMP. CAPPUCINATORE TALENTO CMK	COMPRESSOR END TALENTO CMK	
08000057	BOCCOLA BZ 10x10 FLANGIATA	BZ 10x10 FLANGED BUSHING	
08000071	CUSCINETTO ASSIALE COMPONENTE 10x19x6	MODULAR AXIAL BEARING 19x10x6	
08000083	COPIGLIA ELASTICA D.2 L.43 C70 ZINCATO	RETAINER CLIP D.2 L.43 c70 GALVANISED	
08000084	COPIGLIA D.2 L.20 INOX 304 UNI 1336 - DIN 49 - ISO 1234	RETAINER CLIP D.2 L.20 304 SS UNI 1336 - DIN 49 - ISO 1234	
08000085	MOLLA PALETTA ESPULSIONE GR.TALENTO	TALENTO GROUP SCOOP SPRING	
08000086	MOLLA x TUBO EROGAZ. TALENTO	SPRING TUBE x DRAW. TALENTO	
08000087	MOLLA PISTONE SCARICO L.120 GRUPPO TALENTO	LOWER PISTON LONG SPRING TALENTO	
08000100	MOLLA INTERNA PIEDE 2005	FOOT INNER SPRING 2005	
09000005.1	SONDA AUTOLIVELLO COMP. L=130 CON GOLA	WATER LEVEL SENSOR	
09100002	MANOMETRO SCALA 0-16 BAR 1/8 D.40	PRESSURE GAUGE SCALE 0-16 BAR D40 SS RING NUT STEEL BODY	
09500001	TERMOSTATO RIARMO AUTOM 98°C	98°C AUTO RESET THERMOSTAT	
09500011	TERMOSTATO R.AUTO 150°C FASTON 6,3 VERTICALI	150°C AUTO RESET THERMOSTAT	
09500014	TERMOPROTETTORE RESISTENZA G5 167°C 16A 250V UL	THERMO PROTECTOR	
09500016	TERMOPROTETTORE RESISTENZA L50N G913 184°C 250V	HEATING ELEMENT THERMAL PROTECTION G5 184°C 250V	
11600001.W	TUBO SILICONE BIANCO4x7,5 60Sh(1mt=41gr) SEMITRASPARENTE	WHITE SILICON PIPE 4x7.5 60 ShSEMI-TRANSPARENT	
11600002	TUBO SILICONE 5x8 60Sh PEROX (1mt=37gr) TRASPARENTE	SILICONE TUBE 5x8	

T A L E N T O

CODICE	DESCRIZIONE	DESCRIPTION	END VALIDITY
11600006	TUBO SILICONE 4,8x1,6	SILICON TUBE 4,8x1,6	
11600003	TUBO SILICONE 8x12 70Sh PEROX (1mt=75gr) TRASPARENTE	SILICON TUBE 8X12 70SH PEROX TRANSPARENT	
11740001	TUBO TEFLON 6/4	TEFLON PIPE 4X6	
11740002	TUBO TEFLON 4/2,5 CALIBRATO TRASPARENTE	TEFLON PIPE 4/2.5 CALIBRATED TRANSPARENT	
14100055	RESISTENZA A CARTUCCIA HW10x65 100W 230V	CARTRIDGE HEATING ELEMENT HW10x65 100W 230V	
14100063	RESISTENZA A CARTUCCIA D10x55 18W	CARTRIDGE HEATING ELEMENT HW10x55 18W	
14100088	RESISTENZA 1"1/4 230V 2600W INCOLOY-800 A MATASSA	HEATING ELEMENT 1"1/4 230V 2600W INCOLOY-800 A COIL APPIA C	
98001006	PIEDE MACCHINA 06 BICOMPONENTE D.48 H=40	MACHINE FEET replace 98001001	
98001008	KIT PIEDI ALTI AURELIA (4 PZ)	KIT TALL FEET AURELIA (4 PCS.)	
98003018	VALVOLA RITEGNO 98 ES.16	VALVOLA RITEGNO 98 ES.16 RETAIN VALVE	
98004016	FILTRO INOX DIAM. 12	STAINLESS FILTER DIAM. 12	
98006014	TUBO LANCIA INOX VAPORE L=163 FORO 1 mm TURBOCREAM	SS STEAM TUBE L=163, HOLE 1 mm TURBOCREAM	
98006015	TUBO TEFLON 4x6 INTERNO LANCIA VAPORE L=147 mm.	TEFLON TUBE 4X6 INSIDE STEAM WAND L=147 MM.	
98030075	TUBO CAPILLARE 1/8-1/4 0,9x2x400 MANOMETRO- POMPA	CAPILLARY TUBE 1/8-1/4 0,9X2X400 MANOM.-PUMP	
98030360	CALDAIA CAFFE' D90 L=270 INOX "TALENTO"	TALENTO SS COFFEE BOILER D90 L=270	
98030364	TUBO L.160 CON RACC. 1/8 M-F MISCELATORE TALENTO	DRAFT PIPE WITH 1/8" M-F FITTING	
98060010	LANCIA VAPORE INOX D10 L=200 "TALENTO"	TALENTO SS STEAM WAND	
98060010.A	LANCIA VAPORE INOX AUTOSTEAM "TALENTO"	AUTOSTEAM AND HOT WATER SS STEAM WAND TALENTO	
98060010.G	LANCIA VAPORE INOX AUTOSTEAM ATTACCO 1/8 "TALENTO"	AUTOSTEAM 1/8" SS STEAM WAND TALENTO	
98120002	VALVOLA NEPLAX VITON 6.5 BAR 1/8 - PORTAGOMMA	NEPLAX VITON 6.5 BAR VALVE 1/8 HOSE SUPPORT	
98010000000029	ASSIEME VASCHETTA RACCOGLI ACQUA TALENTO	DRIP TRAY ASSEMBLY TALENTO	
98010000000036	CASSETTO RACCOGLIFONDI COMPL. TALENTO	DREGS DRAWER ASSEMBLY TALENTO	
98010000000037	CASSETTO RACCOGLIFONDI SCARICODIRETTO COMPL. TALENTO	DREGS DRAWER ASSEMBLY (DIRECT DRAIN) TALENTO	
98010000000039	ASSIEME CAMPANA TALENTO	COFFEE BELL ASSEMBLY TALENTO	
98020000000037	ASSIEME CHIUS.SCIVOLO MACININI TALENTO 2011	GRINDER COFFEE CHUTE ASSEMBLY TALENTO 2011	
980100000000440000	ASSIEME VETRO DX TELENTO	TALENTO RIGHT GLASS ASSEMBLY	
980100000000450000	ASSIEME VETRO SX TELENTO	TALENTO LEFT GLASS ASSEMBLY	
980300000000079	ASSIEME CAPPUCCIATORE TALENTO CMK	MILK FROTHER TALENTO CMK ASSEMBLY	
980400000000028	GRUPPO TALENTO LAVORATO	MACHINED GROUP TALENTO	
980400000000030	ASSIEME GRUPPO EROGAZIONE "TALENTO 2008"	POURING GROUP ASSEMBLY "TALENTO 2008"	
981600000000091	ASSIEME TRASFORM+CABLAGGIO TALENTO PLUS	TRANSFORMER AND WIRINGS TALENTO PLUS + EASYCREAM	
981600000000196	SONDA TEMPERATURA GRUPPO TALENTO	TEMPERATURE GROUP PROBE TALENTO	
981700000000032	ASSIEME SUPPORTO + POMPA LATTE TALENTO CMK	MILK PUMP TALENTO CMK + SUPPORT ASSEMBLY	
981700000000033	ASSIEME SUPPORTO + MICROCOMPRESSORE TALENTO	MICROCOMPRESSOR TALENTO + SUPPORT ASSEMBLY	
9803000000000810000	ASSIEME CALDAIA CAFFE' TALENTO 2011	COFFEE BOILER ASSEMBLY D=90 L=270 TALENTO 2011	
9803000000000850000	ASSIEME CALDAIE VAPORE TALENTO 2011	STEAM BOILER ASSEMBLY D=115 L=270 TALENTO 2011	
9803000000000870000	ASSIEME CALDAIE TALENTO 2011	BOILERS ASSEMBLY TALENTO 2011	
982100000000190000	ASS.SUPPORTO E.V. + DOSATORE TALENTO 2011 C/MISCELAT.	E.V. GROUP ASSEMBLY TALENTO 2011 ECONOMIZER VERSION	
9821000000000850000	ASS.SUPPORTO E.V. ARIA + PULIZIA TALENTO CMK	AIR+AUTOWASHING VALVES ASSEMBLY TALENTO CMK	
9821000000000860000	ASS.SUPPORTO E.V.+REGISTRO ARIA TALENTO CMK	AIR REGULATOR + VALVES ASSEMBLY TALENTO CMK	
9821000000000870000	ASS.SUPPORTO E.V.+REGISTRO ARIA EASY CREAM TALENTO	EASYCREAM AIR REGULATOR + VALVES ASSEMBLY TALENTO	

T
A
L
E
N
T
O



PLATONSERVICE

8 (800) 500-34-11

www.platonservice.com